

□ S-2 SURFACE MOUNT

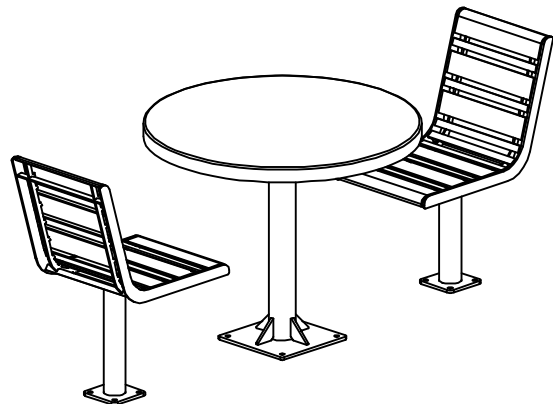

NOTES:

- 1.) ALL STL. MEMBERS COATED W/ ZINC RICH EPOXY THEN FINISHED W/ POLYESTER POWDER COATING.
- 2.) 1/2" X 3 3/4" EXPANSION ANCHOR BOLTS PROVIDED FOR S-2 OPTION.



TABLE

DATE DRAWN : 11/03/17  
 DRAWN BY : ESS  
 DATE REV. :  
 REV. BY :

REV.  
 A

DRAWING  
 NUMBER

296-36-20HS

SHEET  
 1 OF 2

**NOTES:**

- 1.) DURING ASSEMBLY PROCEDURE;  
DO NOT COMPLETELY TIGHTEN HARDWARE.
- 2.) THE ACTUAL PARTS WILL NOT BE NUMBERED.  
NUMBERS ONLY APPLY TO DRAWING.
- 3.) UPON COMPLETION OF ASSEMBLY SQUARE  
ALL COMPONENTS THEN TIGHTEN ALL HARDWARE.
- 4.) MOUNT AND ANCHOR AS SPECIFIED.

**TOOLS REQ'D**

- 3/4" WRENCH
- 1/2" MASONRY DRILL BIT  
DRILL

**PARTS LIST FOR S-2**

ITEM	QTY	PART NO	DESCRIPTION
1	2	0-294-00-03HS	16" STL SEAT
2	1	0-296-00-01/S-2	TABLE SUPT FRAME FOR SURFACE MT
3	2	0-296-00-02/S-2	STL PEDESTAL SEAT SUPPORT, PLATES
4	1	0-296-36-03	36" DIA STL TABLE TOP
5	8	1-11-042	1/2" X 1 1/2" SS CGE BOLT
6	8	1-20-015	1/2" SS NYLON LOCKNUT
7	8	1-22-015	1/2" SS FLAT WASHER

**KITS PROVIDED FOR S-2**

ITEM	QTY	PART NO	DESCRIPTION
8	3	K-ANC0860-4	1/2" X 3 3/4" SS ANCHOR KIT (4PC)
9	2	K-CG0824-4L	1/2" CGE BOLT HARDWARE KIT (4)

① ATTACH TABLE TOP TO TABLE SUPPORT.

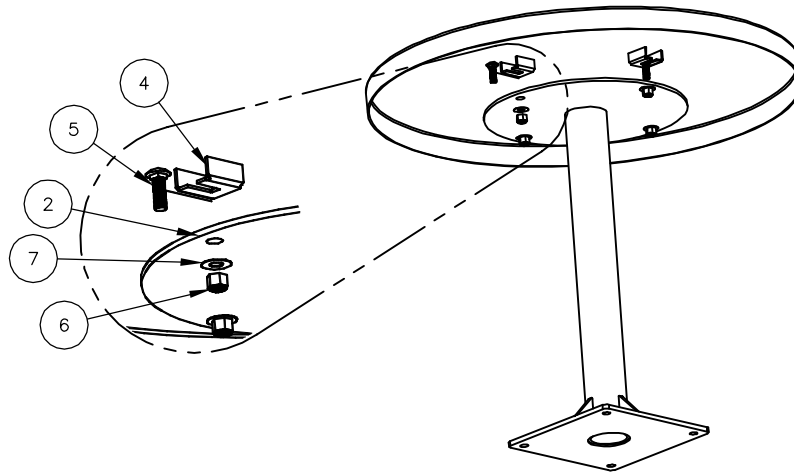

② ATTACH STL. SEAT TO SEAT SUPPORT.

